



User Manual & Safety Guide



Read This Manual

Thoroughly read this manual before assembling or using scaffolding unit. Failure to do so can result in **injury or death.**

Seriously... **read it.**



**ONE YEAR
WARRANTY**

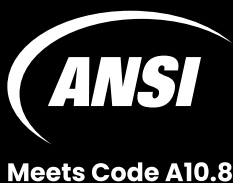

Read Instructions thoroughly before assemblage. Non-compliance with guidelines may result in serious injury or death.

PRIOR TO USE

- Only use scaffold unit as intended while complying with local, state, and national guidelines and legislation.
- A competent person should manually inspect scaffolding prior to each use, ensuring it is in good working condition and that all parts are present and properly assembled.
- Only use on level, hard, even surfaces. Avoid using scaffold on surfaces that are soft, muddy, debris filled, holey or otherwise obstructed.
- Refrain from using scaffolding if you are unwell, taking medication, consuming alcohol, mind-altering drugs or experiencing any other condition that may impair your ability to work.
- Two platforms should be installed on frame structure prior to use, both set level. Scaffold collapse is possible if both platforms are not set level and could result in injury or death.
- Casters must always be secured with span pins and caster brakes must be locked before climbing or standing on scaffolding.
- Do not use any scaffolding component that is damaged or if parts are missing.

DURING USE

- Keep body centered inside structure of scaffold to avoid tipping.
- Maintain a constant firm grip while climbing scaffold. Always maintain three points of contact.
- Keep scaffold free of clutter and unnecessary equipment to avoid tripping while in use.
- If any part of scaffolding unit becomes damaged during use, it should be removed immediately from the work area and replaced.
- Acids are corrosive and exposure diminishes the integrity of scaffold unit. Do not expose to corrosive materials.
- Remove or fasten all tools, material, or equipment before moving scaffolding. Never move scaffold while a person is on unit. Be careful when moving unit to avoid tipping.

- This scaffold should be stored inside, out of the elements and away from excessive heat or corrosive materials. Rust and other forms of corrosion or deterioration compromise the structural integrity of the scaffold and should be avoided. Do not use scaffold if structure is compromised in any way.
- Unit intended to hold a maximum of one person.
- A safe work platform to stand upon should be at least 18 inches wide.
- Remove all tools and materials before moving scaffolding.
- Before using tool shelf, make sure hinges are fully engaged.

DO NOTS

- Never use powered devices to propel this scaffold unit.
- Never stack on loose materials, boxes, or any other non-approved foundation.
- Never move scaffold with personnel on unit.
- Never load unit without caster brakes locked.
- Never use scaffold in windy conditions or during inclement weather.
- Never use on uneven or soft surfaces.
- Never stand or sit on tool shelf. Max shelf capacity 35 lb.
- Never use if any part of the scaffold unit is missing.
- Never modify the scaffolding in any way, doing so voids its warranty.
- Never climb the outside of the unit.



Do Not Over Encumber

This unit was designed for a maximum capacity load of 500 lbs (227 kg)
Per decking unit: 250 lbs (113 kg)
Tool Shelf: 35 lbs (16 kg)



Metal Conducts Electricity





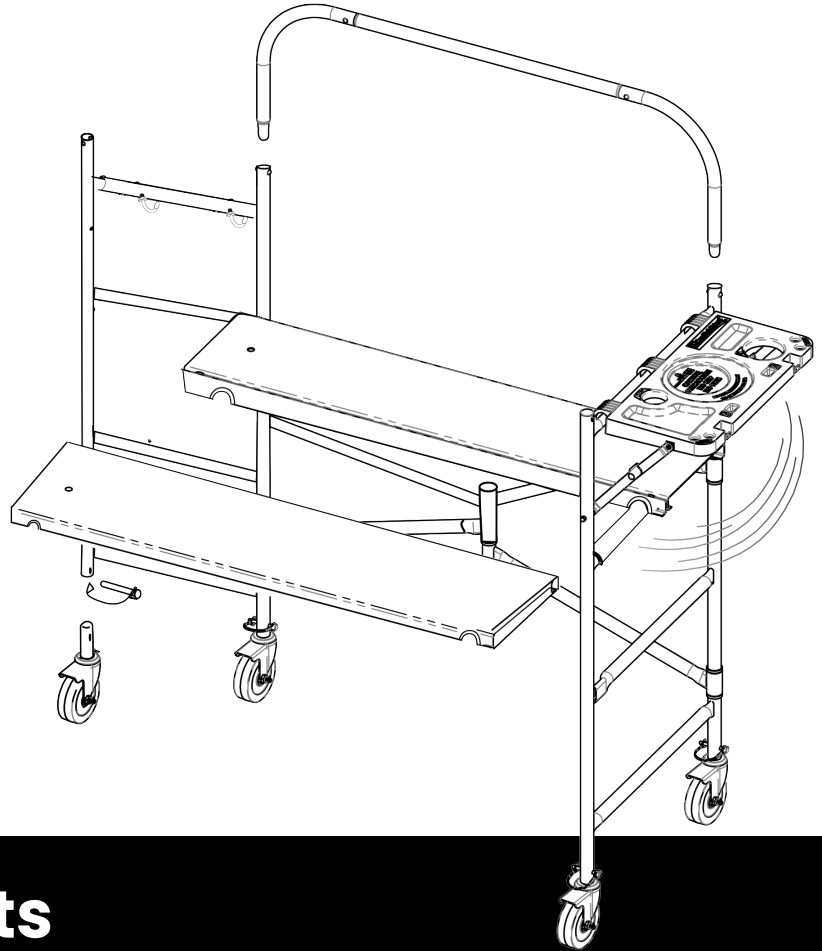

Never use scaffolding unit in proximity to live electrical circuits or power lines.

Assembly Instructions

- 1** Begin on level, firm, unobstructed surface. Unpack box and lay out all the included parts.
- 2** With scaffold laid flat on the ground, insert casters into bottom of unit, securing with included span pins. Lock the brakes on all four wheels before proceeding.
- 3** Stand the scaffold unit up and spread its ends away from one another, keeping them in parallel. Unit will tip if ends are not in parallel.
- 4** With unit extended, place platforms at desired heights. Make certain platforms are properly seated and level, with their semi-circular cut-outs snug against the horizontal supports.
- 5** Install upper handrail by first fastening it's two ends to the center portion. Make certain spring rivets are secure, then install in the vertical tubes of the unit. Again, make certain spring rivets secure all connections.
- 6** Install platform hooks. The top horizontal beam is drilled with two holes, insert hooks through these holes and secure with included nuts.

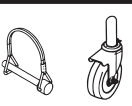

Replacement Parts

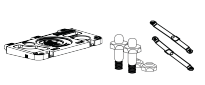
IMAGE	PRODUCT NAME	PART NUMBER
	Anti-Slip Rings	UTLSLIPRING
	J Hook	UTLHOOK
	Tube Caps	UTLCAP
	Span Pin	381SPANPL
	Caster Wheel and Span Pin	MF378-5RP
	Spring Rivet	381SR
	Tool Shelf & Hinge Kit	UTLSHELF

To order these replacement parts, contact our customer service department.

Customer Service:

.....
1 (866) 900-0983
customerservice@scaffoldmart.com
scaffoldmart.com



ONE YEAR WARRANTY

ScaffoldMart guarantees this product against any material defect for a period of one year beginning at the time of purchase. This warranty does not cover damages or injury due to inappropriate or incorrect use, care or maintenance of your unit.

List of Box Contents

- A. Frame Structure (1)
- B. Handrail Assembly (1)
- C. Platforms (2)
- D. Caster Wheels (4)
- E. Span Pins (4)
- F. Hooks w/ Nuts (2)
- G. Spring Rivets (4)

